

ITT

B5-75GSX

Residential Water Systems

Goulds Pumps

GS-CBM GS Xtreme™ 60 Hz
4" Submersible Pumps



FEATURES

- **Field Proven Design:** The GS Xtreme features super strong construction due to the welded casing joints at both ends. The proprietary engineered polymer bearings have been field proven with great success in some of the toughest submersible pump applications on the planet – coalbed methane extraction. They are the deepest set pumps we build, available up to 10 HP in many models. Capable of pumping over 1600' TDH.
- **Powered for Continuous Operation:** All ratings are within the working limits of the motor as recommended by the motor manufacturer. Pump can be operated continuously without damage to the motor.
- **Sand Handling Design:** Our face clearance, floating impeller stack has proven itself for over 40 years as a superior sand handling, durable pump design.
- **Stainless Steel Metal Parts:** AISI types 302, 303 and 304 are corrosion resistant, non-toxic and non-leaching.
- **FDA Compliant Non-Metallic Parts:** Impellers, diffusers and bearing spiders are constructed of glass filled engineered composites. They are corrosion resistant and non-toxic.
- **Discharge Head:** Cast stainless steel discharge head features built-in safety loops and an upthrust limiting stud which is factory set to prevent the rotating assembly from upthrusting. These pumps require a separate field installed external check valve to prevent backflow.
- **Bowls:** Stainless steel for strength and abrasive resistance.
- **Check Valve:** Not supplied, order separately, pumps have 2" NPT discharge threads.
- **Stainless Steel Casing:** Polished stainless steel is strong, attractive and corrosion resistant.
- **Hex Shaft Design:** Six sided shafts for positive impeller drive.
- **Shaft Coupling:** Exposed for ease of field alignment to motor shaft and to check pump rotation.
- **Bearings:** Proprietary engineered polymer bearing material is a super strong, abrasion and heat resistant design.

 **GOULDS PUMPS**

Goulds Pumps is a brand of ITT Corporation.

www.goulds.com

Engineered for life

MODELS AND SPECIFICATIONS

Model	Flow Range GPM	Horsepower Range	Best Eff. GPM	Discharge Connection	Minimum Well Size
5GS	1.2 – 7.5	½ – 3	5	2"	4"
7GS	1.5 – 10	½ – 5	7	2"	4"
10GS	3 – 16	1 – 5	10	2"	4"
18GS	6 – 28	1 – 10	18	2"	4"
25GS	8 – 33	1 – 10	25	2"	4"
33GS	10 – 50	1 – 10	33	2"	4"
40GS	20 – 65	1½ – 7½	40	2"	4"
55GS	20 – 80	1½ – 10	55	2"	4"
75GS	40 – 100	3 – 10	75	2"	4"

Rotation on all units is counterclockwise when viewed from pump discharge end.

"GS" SERIES MATERIALS OF CONSTRUCTION

Part Name	Material
Discharge Head	AISI 303 SS
Bearing Spider – Upper	Glass Filled Engineered Composite
Bearing	Proprietary Eng. Composite
Klipring	AISI 301 SS
Diffuser	Glass Filled Engineered Composite
Impeller	
Bowl	AISI 304 SS
Intermediate Sleeve*	AISI 304 SS, Powder Metal
Intermediate Shaft Coupling*	AISI 304 SS, Powder Metal
Intermediate Bearing Spider*	Glass Filled Engineered Composite
Intermediate Bearing Spider*	AISI 303 SS
Shim	AISI 304 SS
Screws – Cable Guard	AISI 304 SS
Motor Adapter	AISI 303 SS
Casing	AISI 304 SS
Shaft	
Coupling	AISI 304 SS, Powder Metal
Cable Guard	AISI 304 SS
Suction Screen	AISI 304 SS

* Used on larger models.

ORDER NUMBER CODE

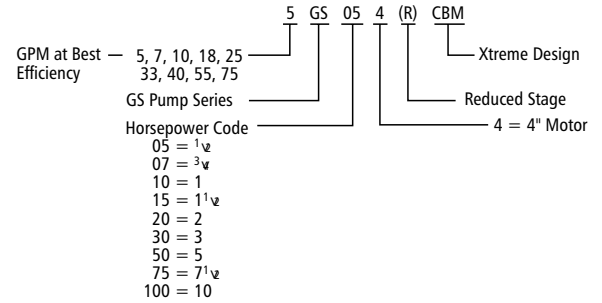

An optional 4" x 6" Adapter – Part No. **ADAPT46** is available for installations where a 6" motor is desired. The kit contains a 4" x 6" adapter, a 4" to 6" splined shaft extension and required bolts.

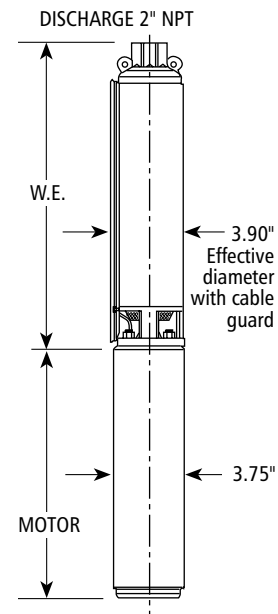

DIMENSIONS AND WEIGHTS

Model	HP	Stages	Length (W.E.)	W.E. Weight (lbs.)
5GS05CBM	½	12	14.8	9
5GS07CBM	¾	15	16.8	10
5GS10CBM	1	20	20.0	12
5GS15CBM	1½	26	25.3	15
5GS20CBM	2	33	30.1	19
5GS30CBM	3	46	42.7	25
7GS05CBM	½	10	13.3	8
7GS07CBM	¾	13	15.4	10
7GS10CBM	1	17	18.3	11
7GS15CBM	1½	22	21.9	13
7GS20CBM	2	27	26.6	16
7GS30CBM	3	34	31.6	20
7GS50CBM	5	54	49.6	28
10GS10CBM	1	12	14.4	10
10GS15CBM	1½	17	17.9	12
10GS20CBM	2	20	20.0	13
10GS30CBM	3	27	26.0	17
10GS50RCBM	5	35	32.5	21
10GS50CBM	5	42	36.3	22
18GS10CBM	1	8	13.0	8
18GS15CBM	1½	11	15.5	10
18GS20CBM	2	14	18.1	11
18GS30CBM	3	19	22.4	13
18GS50RCBM	5	24	27.8	16
18GS50CBM	5	30	33.9	19
18GS75CBM	7½	45	46.7	30
18GS100CBM	10	60	61.7	39

Model	HP	Stages	Length (W.E.)	W.E. Weight (lbs.)
25GS10CBM	1	7	12.8	7
25GS15CBM	1½	9	14.6	9
25GS20CBM	2	11	16.5	10
25GS30CBM	3	15	20.2	12
25GS50RCBM	5	22	28	16
25GS50CBM	5	25	30.9	19
25GS75CBM	7½	34	40.5	24
25GS100CBM	10	50	58.0	31
33GS10CBM	1	6	14.2	9
33GS15CBM	1½	8	16.6	10
33GS20CBM	2	10	19.1	11
33GS30CBM	3	14	24	14
33GS50CBM	5	22	35.1	20
33GS75CBM	7½	34	50.6	28
33GS100CBM	10	44	62.9	34
40GS15CBM	1½	5	13.0	8
40GS20CBM	2	6	14.2	9
40GS30CBM	3	8	16.6	10
40GS50CBM	5	14	24.0	14
40GS75CBM	7½	21	34.0	20
55GS15CBM	1½	5	17.1	10
55GS20CBM	2	7	21.2	13
55GS30CBM	3	9	25.3	16
55GS50CBM	5	15	39.0	23
55GS75CBM	7½	22	54.0	31
55GS100CBM	10	29	68.8	39
75GS30CBM	3	7	24.1	15
75GS50CBM	5	11	34.8	20
75GS75CBM	7½	16	48.2	28
75GS100CBM	10	21	64.0	35

CENTRIPRO 4" SINGLE PHASE MOTORS

Order No.	Type	HP	Volts	Length		Weight	
				In.	MM	Lb.	Kg.
M05421	2-wire PSC	.5	115	11.0	279	19.2	8.7
M05422		.5		11.0	279	19.2	8.7
M07422		.75		12.4	314	22.7	10.3
M10422		1		13.3	337	24.5	11.1
M15422		1.5		14.9	378	28.9	13.1
M05411	3-wire	.5	115	10.0	253	18.9	8.6
M05412		.5		9.7	246	18.1	8.2
M07412		.75		10.8	275	21.4	9.7
M10412		1		11.7	297	23.1	10.5
M15412		1.5		13.6	345	27.4	12.4
M20412		2		15.1	383	31.0	14.1
M30412		3		18.3	466	40.0	18.1
M50412		5		27.7	703	70.0	31.8

CENTRIPRO 4" THREE PHASE MOTORS

Order No.	HP	Volts	Length		Weight		
			In.	MM	Lb.	Kg.	
M05430	½	200	10.8	275	22	9.7	
M07430	¾		10.8	275	22	9.7	
M10430	1		11.7	297	23.1	10.5	
M15430	1.5		11.7	297	23.1	10.5	
M20430	2		13.8	351	27.4	12.4	
M30430	3		15.3	389	32	14.5	
M50430	5		21.7	550	55	24.9	
M75430	7.5		27.7	703	70	31.8	
M05432	½		230	10.8	275	22	9.7
M07432	¾			10.8	275	22	9.7
M10432	1	11.7		297	23.1	10.5	
M15432	1.5	11.7		297	23.1	10.5	
M20432	2	13.8		351	27.4	12.4	
M30432	3	15.3		389	32	14.5	
M50432	5	21.7		550	55	24.9	
M75432	7.5	27.7		703	70	31.8	
M05434	½	460		10.8	275	22	9.7
M07434	¾			10.8	275	22	9.7
M10434	1		11.7	297	23.1	10.5	
M15434	1.5		11.7	297	23.1	10.5	
M20434	2		13.8	351	27.4	12.4	
M30434	3		15.3	389	32	14.5	
M50434	5		21.7	550	55	24.9	
M75434	7.5		27.7	703	70	31.8	

PERFORMANCE CURVES

5GSCBM Curve

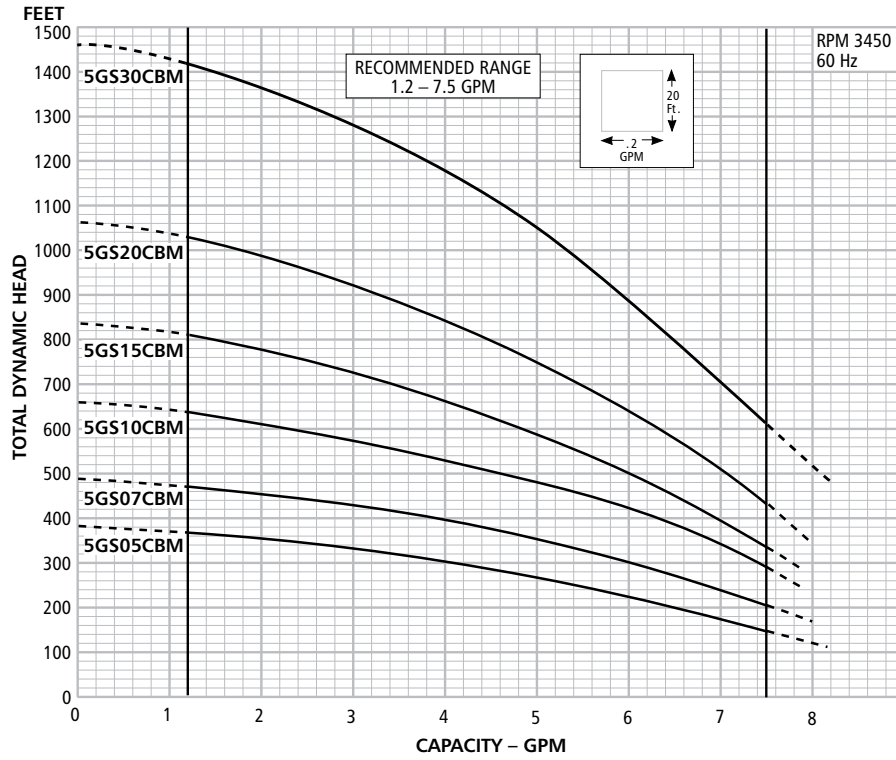

7GSCBM Curve

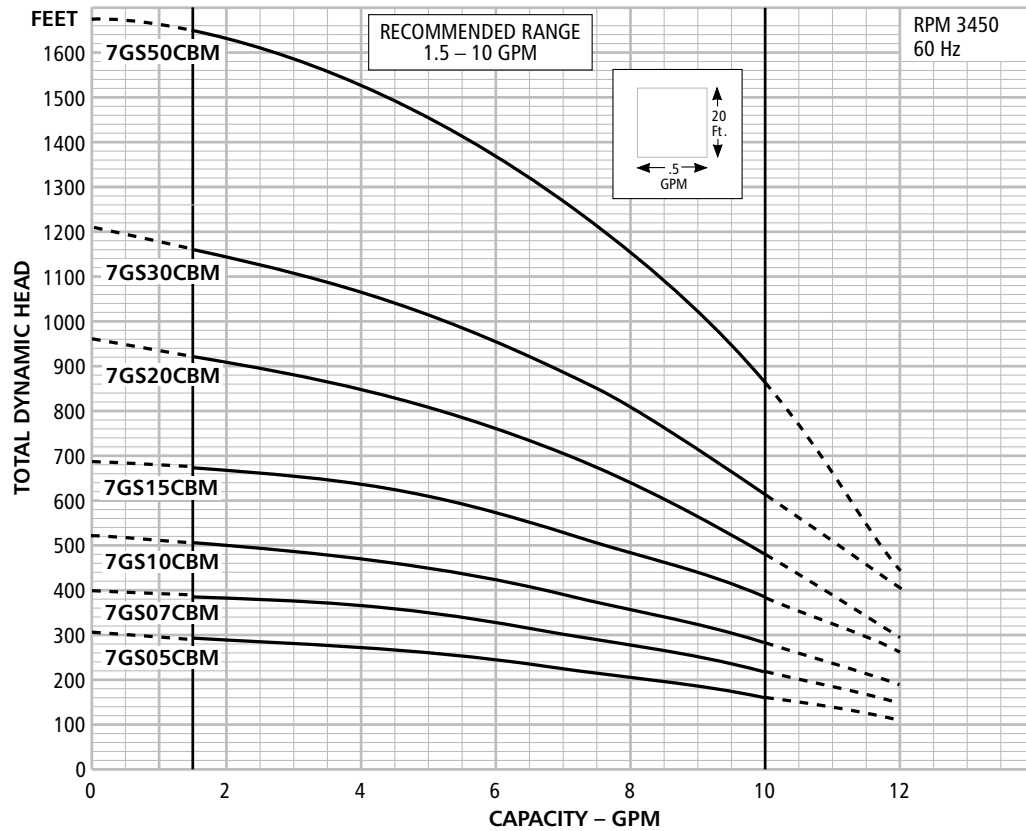

PERFORMANCE CURVES

10GSCBM Curve

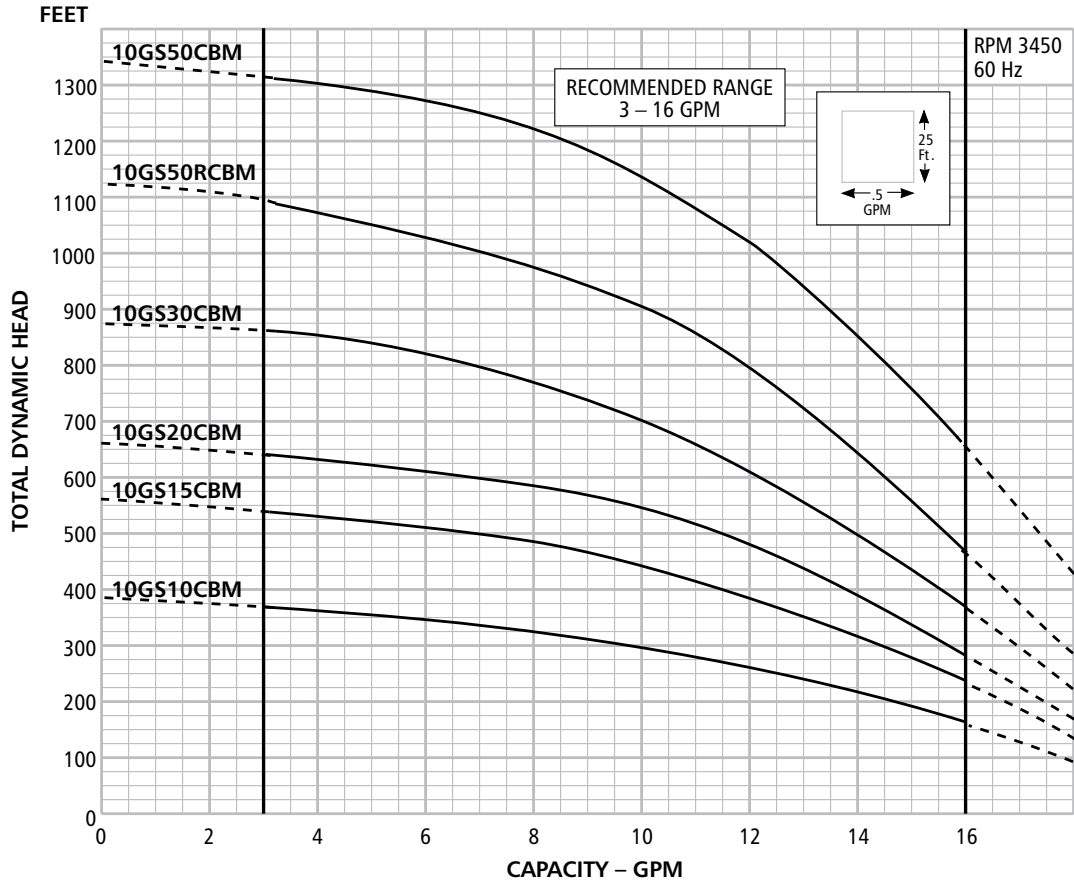

18GSCBM Curve

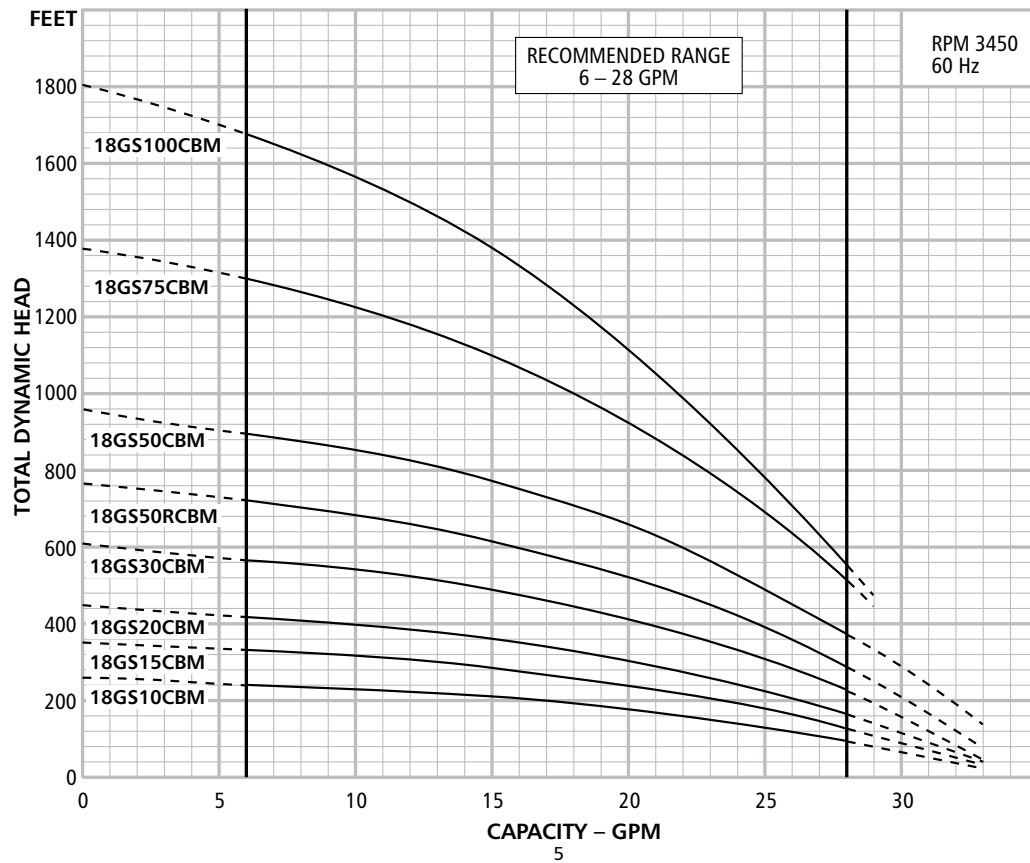

PERFORMANCE CURVES

25GSCBM Curve

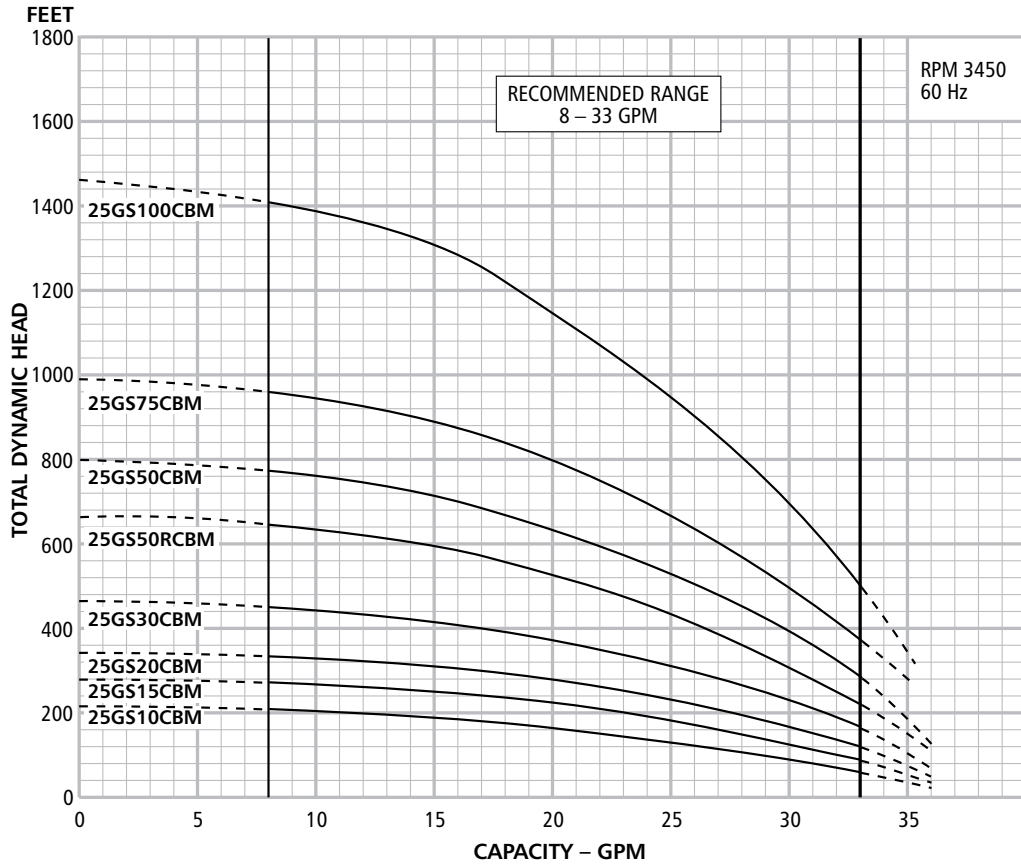

33GSCBM Curve

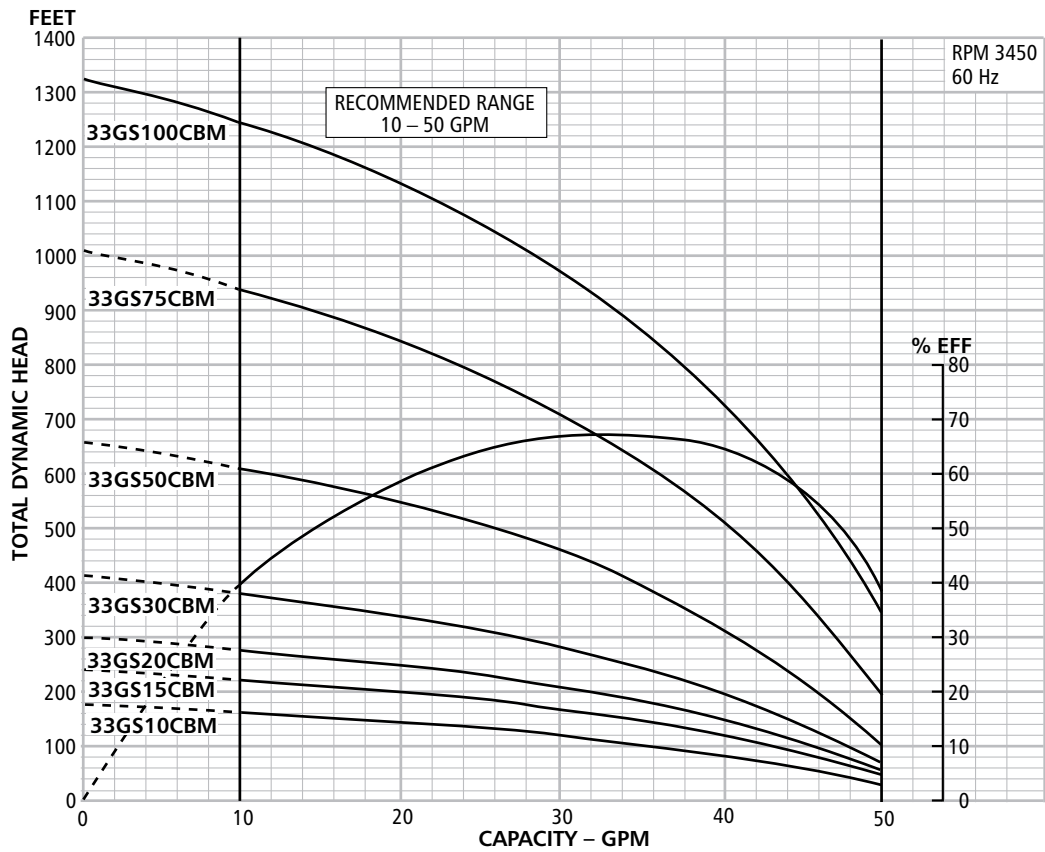

PERFORMANCE CURVES

40GSCBM Curve

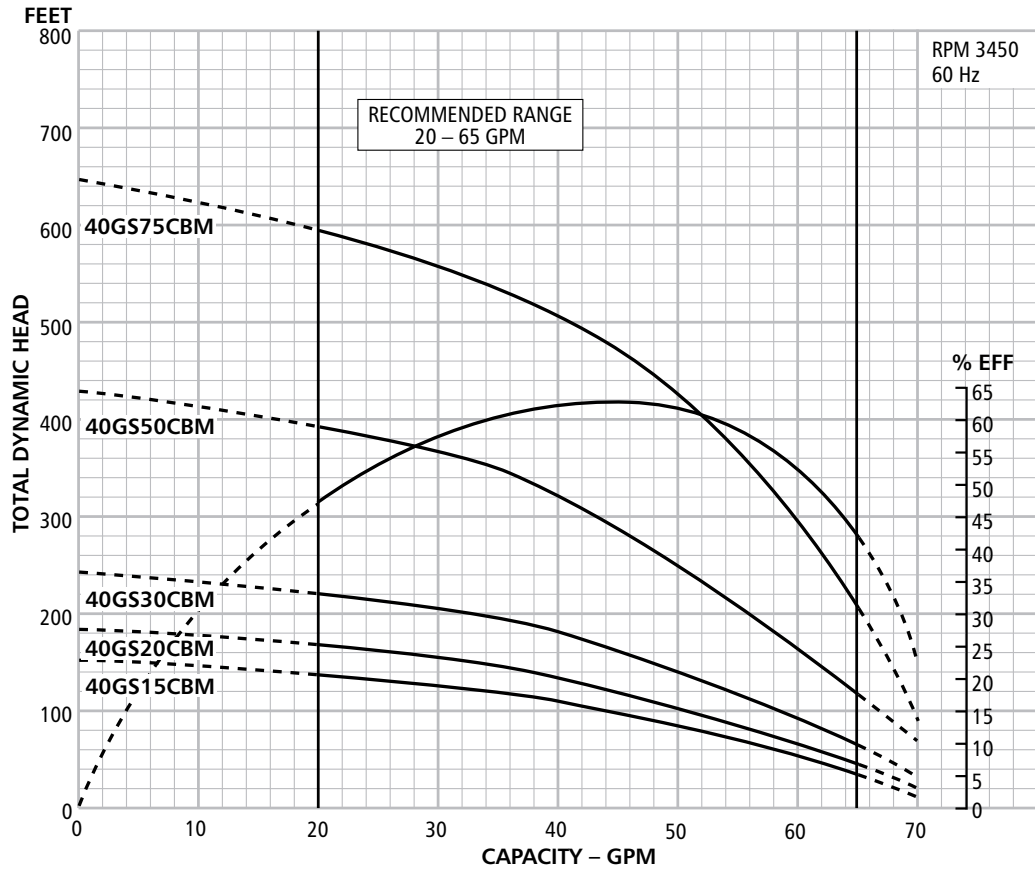

55GSCBM Curve

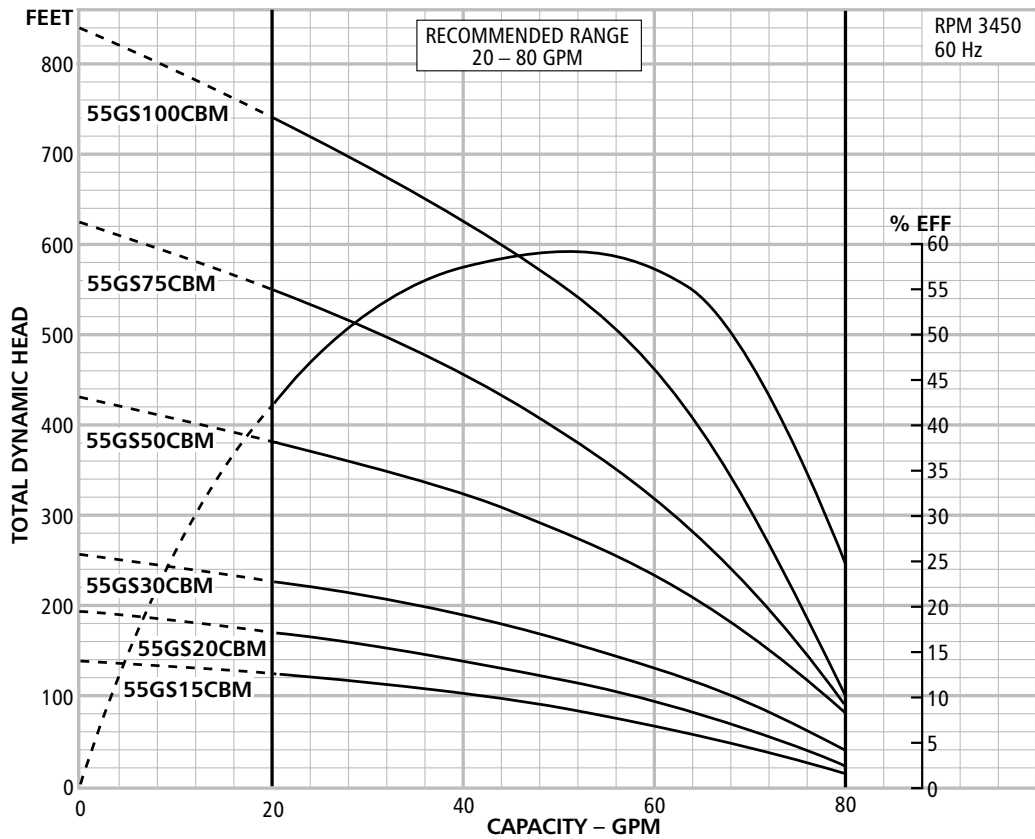

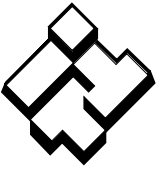

ITT

Residential Water Systems

PERFORMANCE CURVES

75GS CBM Curve

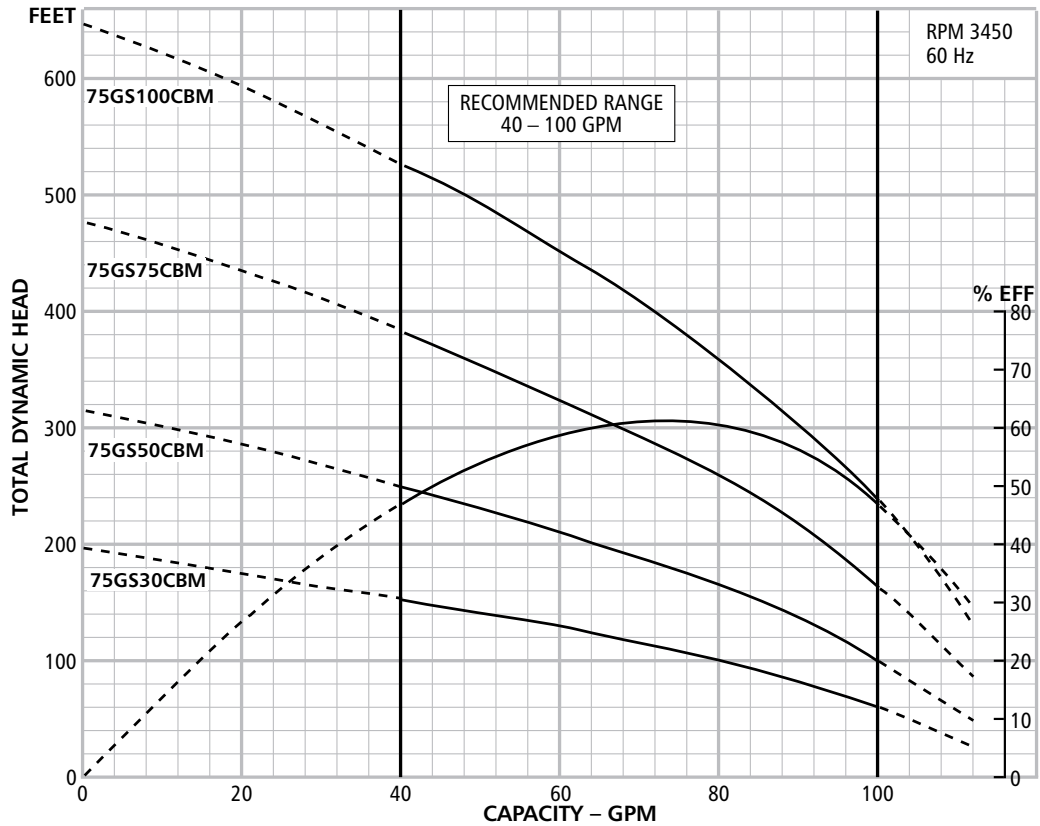

Goulds Pumps and GS Xtreme are registered trademarks of ITT Corporation. ITT, the Engineered Blocks Symbol and Engineered for Life are Registered trademarks of ITT Manufacturing Enterprises, Inc.

SPECIFICATIONS ARE SUBJECT TO CHANGE WITHOUT NOTICE.

B5-75GSX May, 2009
Copyright (c) 2009 ITT Corporation

Engineered for life

Goulds Pumps is ISO 9001 Registered.

Printed in the U.S.A. on recycled paper.